

Veriton S6660G (VS 6660G)

Veriton S4660G (VS 4660G) / Veriton S4665G (VS4665G)

Veriton S2660G (VS 2660G) / Veriton S2665G (VS2665G)

Recycling Guide

Disassembly Procedure	3
Troubleshooting	18
Exploded diagrams	21
FRU (Field Replaceable Unit) List.....	22
To update your software	23
To remove your personal data	23

Disassembly Procedure

● Safety Guidelines

This chapter contains step by step procedures on how to remove and de-install components from the computer. Use the following safety guidelines to ensure your personal safety. Each procedure included in this chapter assumes that you are preparing your computer for recycling and disposal. **By performing any of these procedures you acknowledge that any remaining warranty applicable to your computer will be voided. Before you start any of the procedures in this chapter, make sure to read the following safety guidelines and the respective instructions within the chapter.**

CAUTION!

- Turn off your computer and disconnect all power sources before opening the computer cover or panels.
- To avoid electrostatic discharge, ground yourself by using a wrist grounding strap or by periodically touching an unpainted metal surface at the same time as touching a connector on the back of the computer.
- Take off any metal objects on your arms or fingers such as bracelets, rings or watches and make sure your hands are completely dry. Even if your unit is unplugged, there may still be some remaining electric charge.
- If a component does not come out easily, do not forcefully remove it. Instead, check that you are removing it correctly and that no wires or other parts are in the way.
- When you disconnect a cable, pull on its connector or on its pull-tab, not on the cable itself. Some cables have connectors with locking tabs; if you are disconnecting this type of cable, press in on the locking tabs before you disconnect the cable.

● Recommended Equipment

The following equipment are recommended to do the following maintenance procedures:

- Wrist grounding strap and conductive mat
- Flat screwdriver
- Philips screwdriver
- Polydrive screwdriver
- Plastic tweezers
- Flat plastic pry

● **WEEE Annex VII Component**

These components are classified as requiring selective treatment.

● **Pre-disassembly Instructions**

Do the following prior to starting any maintenance procedures:

1. Place the system on a stable work surface.
2. Remove AC power cord from the system and peripherals
3. Remove all cables from the system.

⇒ NOTE:

Make sure the system is completely powered off.

Chassis Door Removal

1. Remove the two (2) screws from the chassis door

Remove the 2 screws

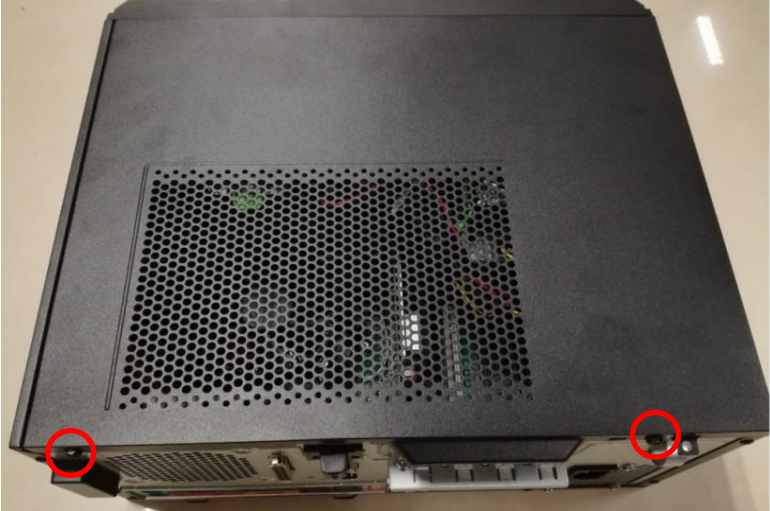

Remove the left side cover



ODD and card reader Module Removal

2. Remove the ODD

2.1 Disconnect the ODD SATA cables and ODD power-cables from the rear of ODD



2.2 Press the tail of ODD to pushing it out of chassis

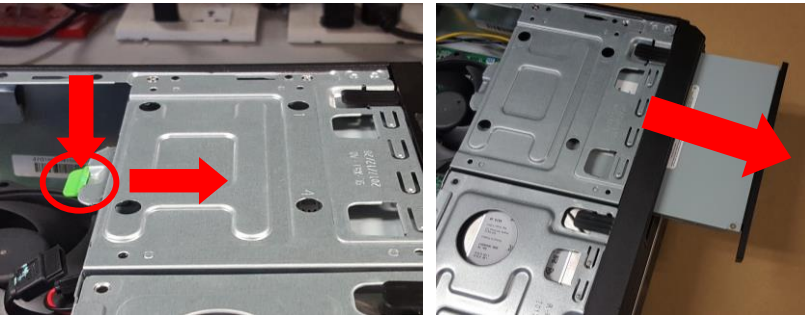

2.3 Remove the ODD

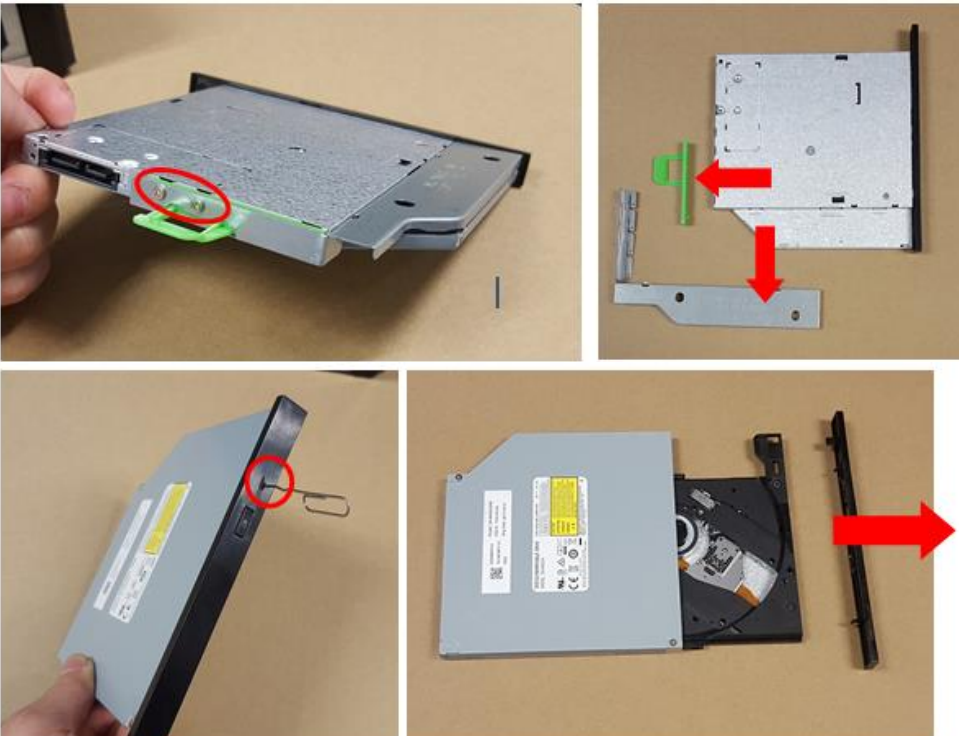

HDD Removal

3. Remove HDD

3.1 Disassemble front bezel



3.2 Disconnect the SATA cables and SATA power-cables from HDD1 and HDD2

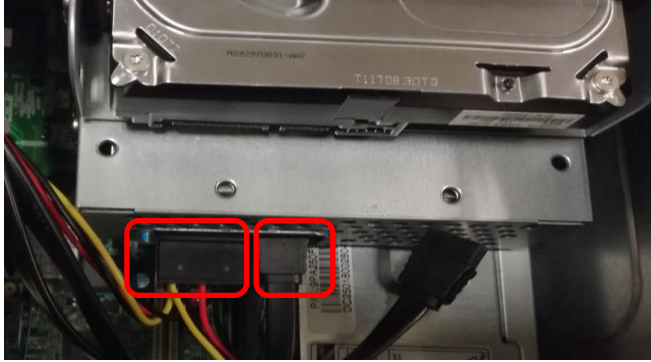
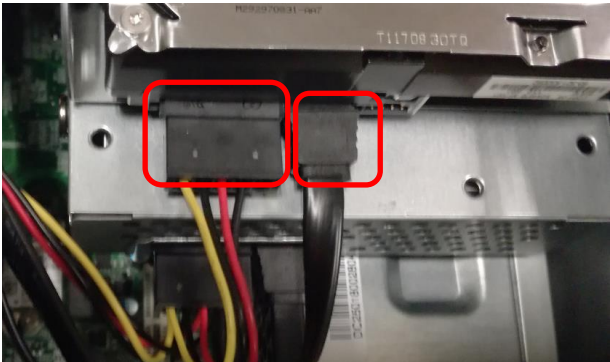

3.3 Remove three screws fastening HDD cage



3.4 Remove the HDD cage from chassis



3.5 Remove HDD from green rack



ODD tray and Card reader Removal

4. Disassemble ODD tray

4.1 Remove five screws fastening ODD tray



4.2 Lifting up the ODD tray to remove it



4.3 Disconnect card reader cable from MB

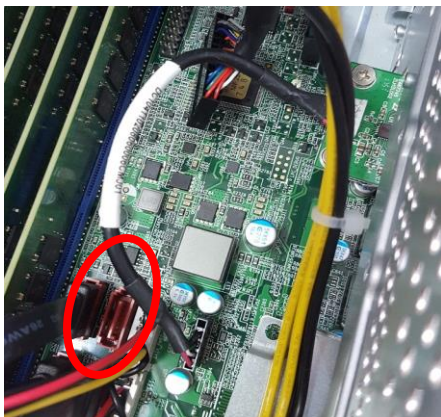

4.4 Remove two screws fastening FIO bracket then remove FIO bracket from chassis

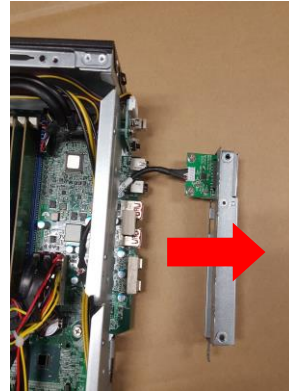
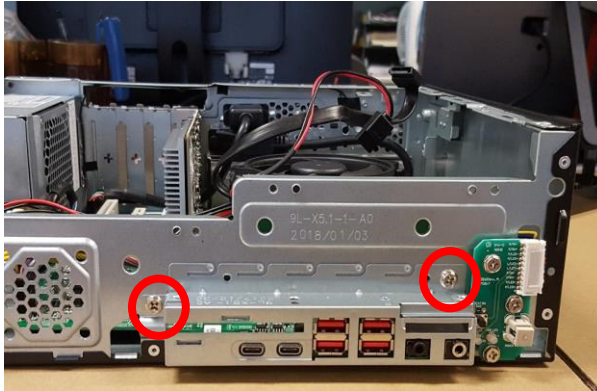

4.5 Remove two screw and pull SD card reader out

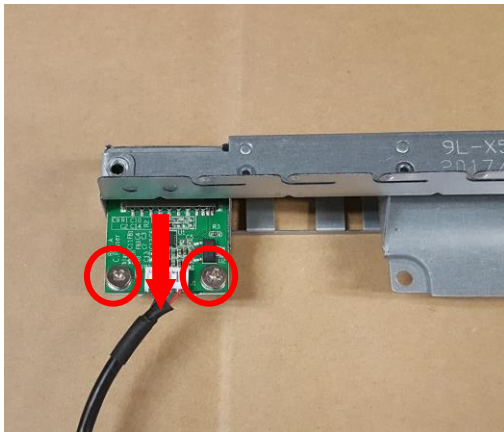

VGA card Removal

5. Remove VGA Card

5.1 Remove a screw and open the PCI bracket

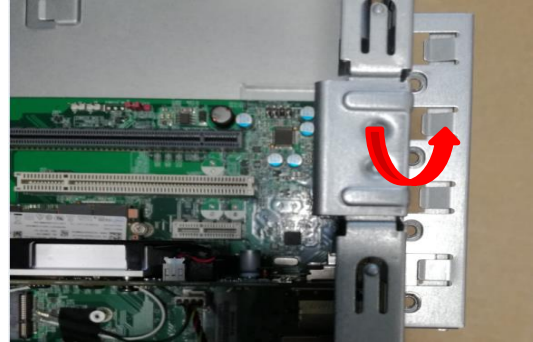

Press the PCI slot latch down and lift up the VGA card



PSU Removal

6. Remove internal PSU

6.1 Cut the cable ties to release cables and disconnect ATX_12V and ATX_power cable on MB

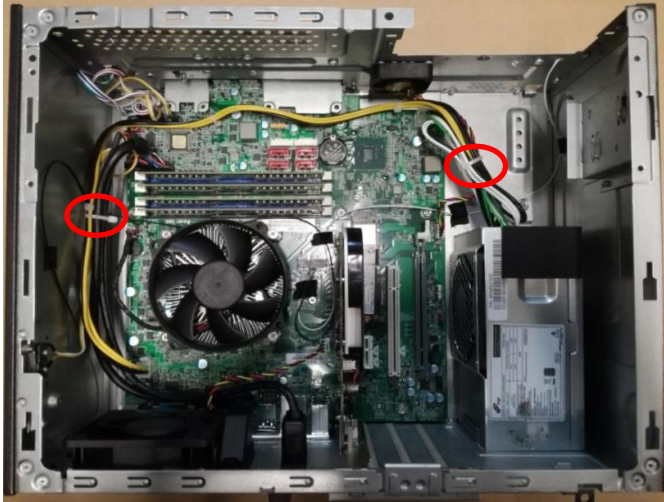

6.2 Disconnect the PSU cable with MB

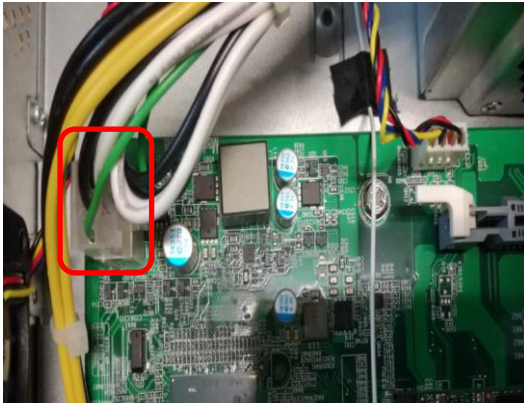

6.3 Remove four screw fastening PSU and pull it out

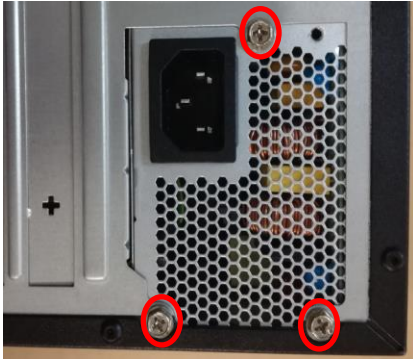

6.4 Remove a screw to disassemble PSU bracket



MotherBoard, MEM, CPU, Cooler, WLAN, SSD, RTC Battery Removal

7. Remove the Main Board

7.1 Disconnect LPT and COM cable from M/B



7.2 Disconnect intrusion alarm and panel cables from MB



7.3 Disconnect SATA and SATA-power cables from MB

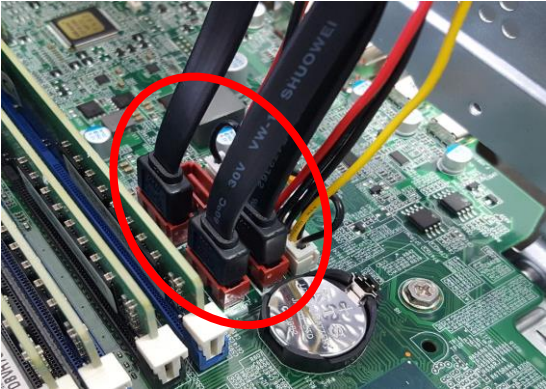

7.4 Release the four latch show bellow then remove the Memory

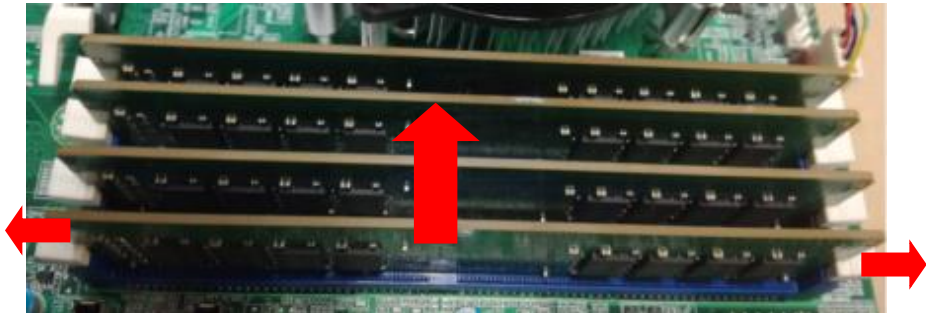

7.5 Remove eight screws and remove the MB

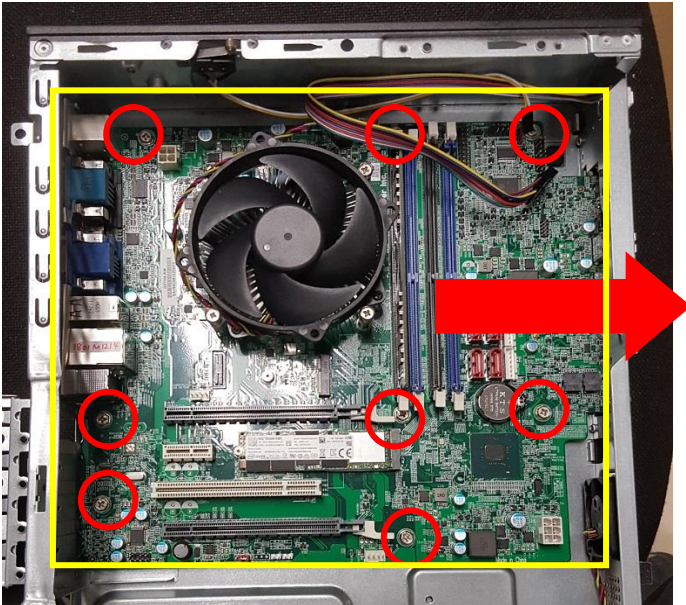

NOTE: Circuit boards $>10\text{ cm}^2$ has been highlighted with the yellow circle as above image shows. WEEE Annex VII component

7.6 Remove a screw and pull M.2 SSD card out then remove thermal pad.



7.7 Remove the four captive screws fastening CPU cooler and disconnect fan power cable from MB then remove CPU cooler

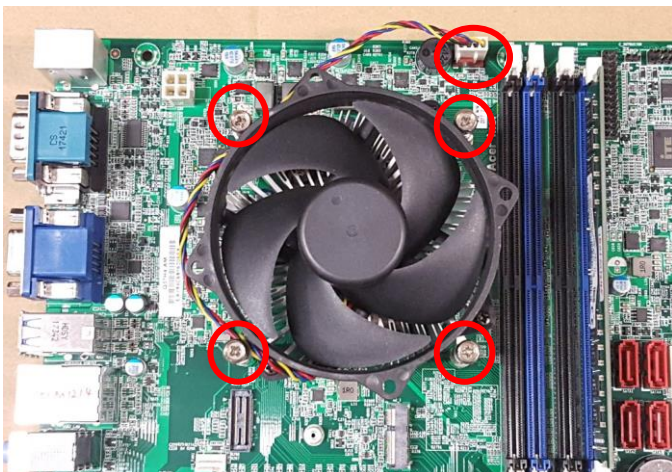

7.8 Unlock CPU socket latch and remove CPU

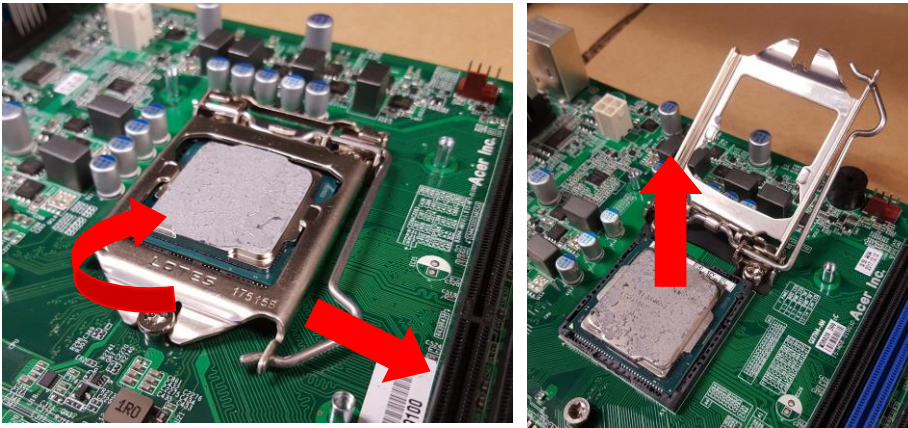

7.9 Remove the battery

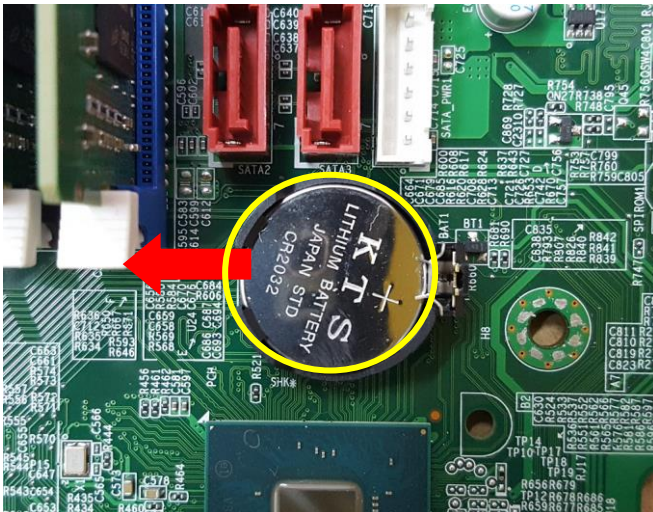

NOTE: RTC battery has been highlighted with the yellow circle as above image shows. WEEE Annex VII component

Troubleshooting

This chapter provides troubleshooting information for the Veriton S series Service Guide

- Power-On Self-Test (POST)
- POST Error Messages List

Power-On Self-Test (POST)

Each time you turn on the system, the Power-on Self Test (POST) is initiated. Several items are tested during POST, but for the most part transparent to the user.

The Power-On Self Test (POST) is a BIOS procedure that boots the system, initializes and diagnoses the system components, and controls the operation of the power-on password option. If POST discovers errors in system operations at power-on, it displays error messages on screen, generates a check point code at port 80h or even halts the system if the error is fatal.

The main components on the main board that must be diagnosed and/or initialized by POST to ensure system functionality are as follows:

- Microprocessor with built-in numeric co-processor and cache memory subsystem
- Direct Memory Access (DMA) controller
- Interrupt system
- Three programmable timers
- ROM subsystem
- RAM subsystem
- CMOS RAM subsystem and real time clock/calendar with battery backup
- Onboard parallel interface controller
- Embedded hard disk interface and one diskette drive interface
- Keyboard and auxiliary device controllers
- I/O ports
 - One parallel port
 - One PS/2-compatible mouse port
 - One PS/2-compatible keyboard port

POST Error Messages List

If you cannot run the diagnostics program tests but did receive a POST error message, use “POST Error Messages List” to diagnose system problems. If you did not receive any error message, look for a description of your error symptoms in “Error Symptoms List”.

If you are unable to correct the problem by using the “BIOS Messages List” table and “Error Symptoms List” table, go to “Undetermined Problems”.

To diagnose a problem, first find the BIOS error messages in the left column. If directed to a check procedure, replace the FRU indicated in the check procedure. If no check procedure is indicated, the first Action/FRU listed in right column is the most likely cause.

BIOS Messages	Action/FRU
BIOS ROM checksum error - System halted	The checksum of the BIOS code in the BIOS chip is incorrect, indicating the BIOS code may have become corrupt. Contact your system dealer to replace the BIOS.
CMOS Battery Failed	The CMOS battery is no longer functional. Contact your system dealer for a replacement the BIOS.
CMOS Checksum Error- defaults loaded	Checksum of CMOS is incorrect, so the system loads the default equipment configuration. A checksum error may indicate that CMOS has become corrupt. A weak battery may have caused this error. Check the battery and replace if necessary.
CPU at run	Displays the running speed of CPU.
Display switch is set incorrectly	The display switch on the motherboard can be set to either monochrome or color. This message indicates the switch is set to a different setting than indicated in Setup. Determine which setting is correct, and then either turn off the system and change the jumper, or enter Setup and change the Video selection.
Press ESC to skip memory test	The user may press Esc to skip the full memory test.
HARD DISK initializing - Please wait a moment	Some hard drives require extra time to initialize.
HARD DISK INSTALL FAILURE	Cannot find or initialize the hard drive controller or the drive. Make sure the controller is installed correctly. If no hard drives are installed, be sure the Hard Drive Selection in Setup is set to NONE.
Hard disk(s) diagnosis fail	The system may run specific disk diagnostic Routines. This message appears if one or more hard disks return an error when the diagnostics run.
Keyboard Error Or No Keyboard Present	Cannot initialize the keyboard. Make sure the keyboard is attached correctly and no keys are pressed during POST. To purposely configure the system without a keyboard, set the error halt condition in Setup to HALT ON ALL, BUT KEYBOARD. The BIOS then ignores the missing keyboard during POST.
Keyboard is locked out - Unlock the key	This message usually indicates that one or more keys have been pressed during the keyboard tests. Be sure no objects are resting on the keyboard.
Memory Test:	This message displays during a full memory test, counting down the memory areas being tested.
Memory test fail	If POST detects an error during memory testing, additional information appears giving specifics about the type and location of the memory error.

BIOS Messages	Action/FRU
Override enabled - Defaults loaded	If the system cannot boot using the current CMOS configuration, the BIOS can override the current configuration with a set of BIOS defaults designed for the most stable, minimal-performance system operations.
Press TAB to show POST screen	System OEMs may replace the Phoenix Technologies Award BIOS POST display with their own proprietary display. Including this message in the OEM display permits the operator to switch between the OEM display and the default POST display.
Primary master hard disk fail	POST detects an error in the primary master hard drive.
Primary slave hard disk fail	POST detects an error in the secondary master hard drive.
Secondary master hard disk fail	POST detects an error in the primary slave hard drive.
Secondary slave hard disk fail	POST detects an error in the secondary slave hard drive.

Exploded Diagrams

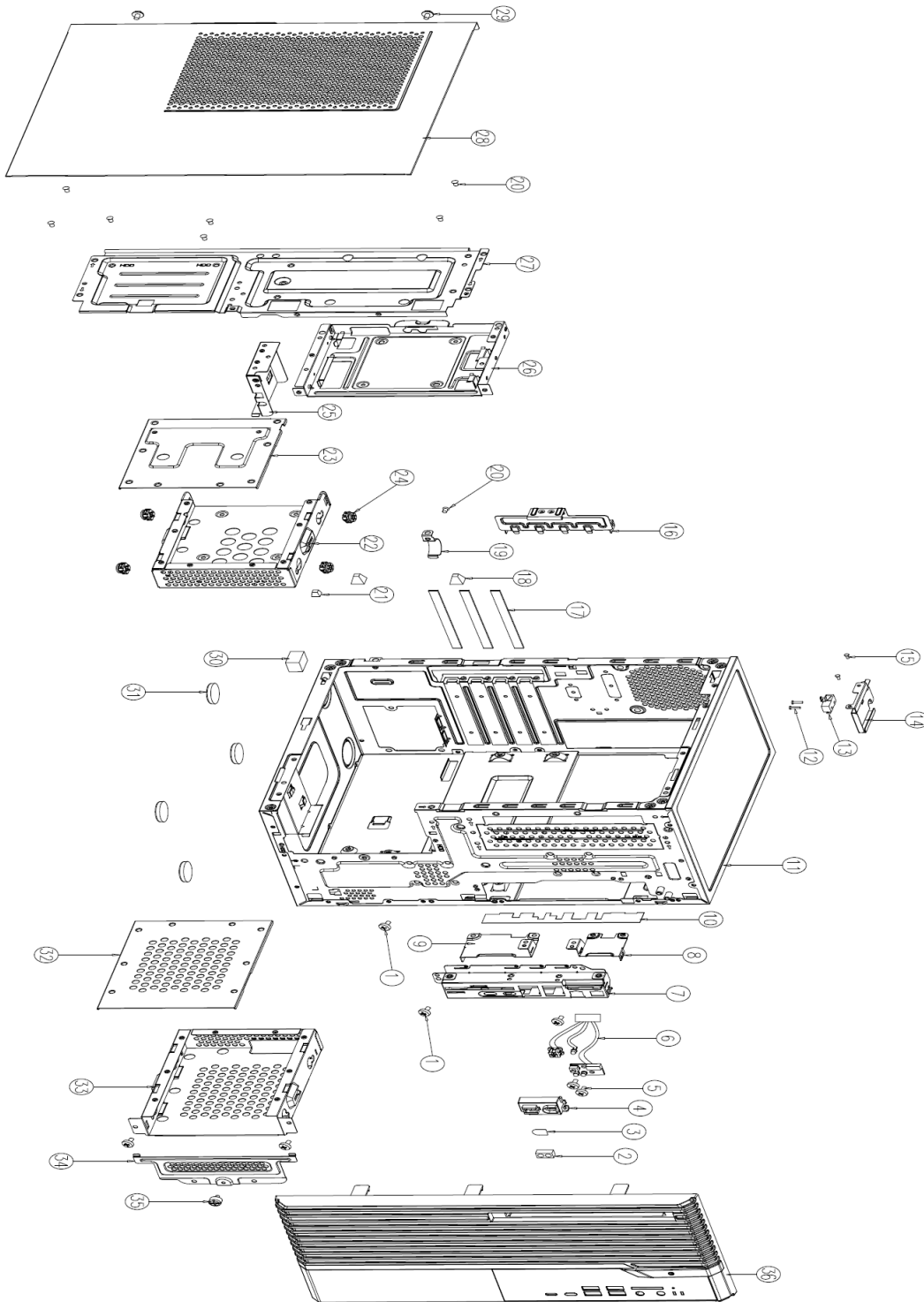

Figure 1 System Exploded Diagram







FRU (Field Replaceable Unit) List

Please contact your local service center to find out how to obtain the part or replace your device

To update your software

Please visit <http://go.acer.com/?id=17883>

To remove your personal data

- Option 1: Select **Start**  > **Settings**  > **Update & Security**  > **Recovery**. Under **Reset this PC**, select **Get started**. [Open Recovery settings](#).
- Option 2: Restart your PC to get to the sign-in screen, then press and hold down the **Shift key** while you select the **Power**  icon > **Restart** in the lower-right corner of the screen. After your computer restarts, select **Troubleshoot** > **Reset this PC**.
- Option 3: Select **Start** , then press and hold down the **Shift key** while you select the **Power**  icon > **Restart** to restart your computer into Recovery Mode. After your computer restarts, select **Troubleshoot** > **Reset this PC**.